

Getting Started with TDSET3

You can use this side of the Quick Reference Card to get started with testing the Ethernet's physical layer for 1000Base-T Templates. The other side contains a complete menu tree for the TDSET3 application.

NOTE. For complete operating instructions, refer to the application Online Help.

TDSET3 Ethernet Compliance Test Software enables unprecedented efficiency by providing a comprehensive range of tests, including Return Loss.

Testing 1000Base-T Templates

Follow these steps:

1. Connect the probes to the Device Under Test (DUT). The test setup for 1000Base-T Template is shown.

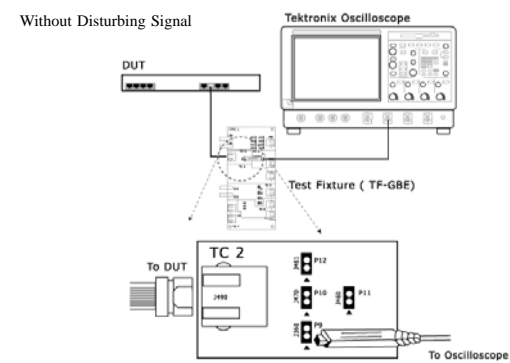
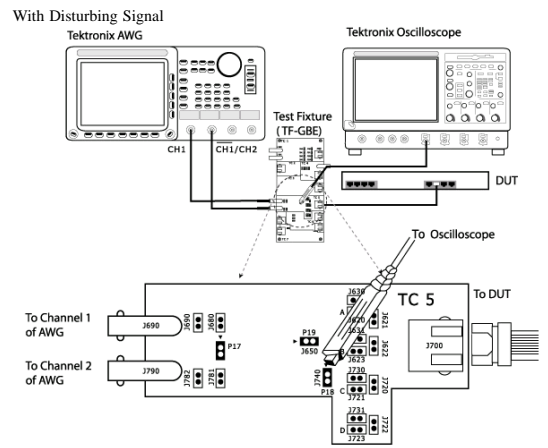

2. Select File > Run Application > Ethernet Compliance Test Software in the oscilloscope menu bar or Analyze > Ethernet Compliance Test Software.

For up-to-date information on Tektronix oscilloscope solutions for Ethernet Compliance Test Software, access the www.tektronix.com Web page.

TDSET3 Ordering Information

This application supports the TDS5000B series, TDS6000/B/C series, TDS/CSA7000B series, TDS/CSA7000, and DPO7000 series of oscilloscopes. Refer to the *Optional Applications Software on Windows-Based Oscilloscopes Installation Manual* for a list of specific models. The applications CD includes a PDF file of the installation manual.

3. Click 1000-T in the Speed pane or select Tests > Select > 1000BASE-T from the menu bar.
4. From the Template/Volt tab, click Select All. You can also select one template at a time to test.

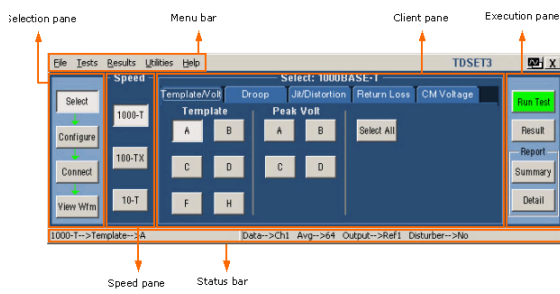

5. Click the Configure button from the Selection pane, or select Tests > Configure from the menu bar to change the configuration settings.

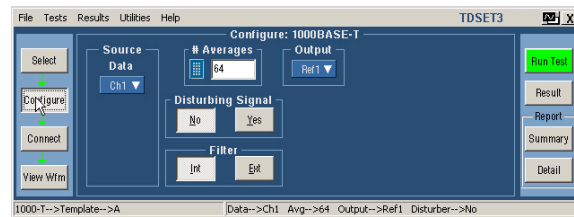

6. Select the data source, number of averages, filter, and the reference waveform to store the processed waveform.
7. To test Templates with Disturbing Signal, select Disturbing Signal as Yes. The Tektronix AWG waveform files are available at C:\TekApplication\TDSET3\AWG Waveforms. To test Templates without disturbing signal, select Disturbing Signal as No and skip steps 8 through 11.
8. Click Connect from the Selection pane and click the JigMatch button. Select Help and connect accordingly. To compensate for nonlinearities in the disturbing signal and the test fixture, use JigMatch (steps 9 through 11). Otherwise go to step 12.

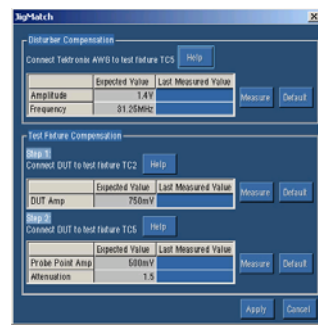

If you order Option ET3 along with TDS5000B, TDS6000/B/C, TDS/CSA7000B, TDS/CSA7000, and DPO7000:

- Ethernet Compliance Test Software is installed and enabled

To order an upgrade for an existing oscilloscope:

- Order TDS5BUP - Opt. ET3
- Order TDS6UP - Opt. ET3
- Order TDS6BUP - Opt. ET3
- Order TDS7BUP - Opt. ET3
- Order TDS7UP - Opt. ET3
- Order CSA7BUP - Opt. ET3
- Order CSA7UP - Opt. ET3
- Order DPO7UP - Opt. ET3

Recommended Accessories

- Ethernet Test Fixture from Crescent Heart Software (www.c-h-s.com)

9. To measure the disturbing signal, connect the Tektronix AWG to the TC5 area of the test fixture and click Measure.
10. To compensate for non-linearities in the test fixture, connect the DUT to the TC2 area of the test fixture and click Measure. This measures the DUT Amplitude.
11. Next, to measure the Probe Point Amplitude and Attenuation, connect the DUT to the TC5 area of the test fixture, and click Measure. Click Apply.
12. Click View Wfm from the Selection pane. If the acquired waveform looks similar to the one displayed by TDSET3, continue to step 13. If the waveforms do not match, check the connection and the configuration. Ensure that the first pulse is rising.
13. Click Run Test in the Execution pane. The application displays the resulting waveform and the results.

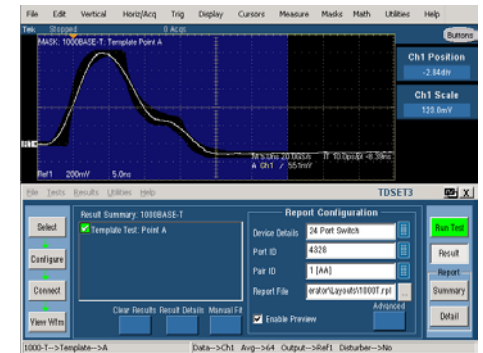

14. Click Result in the Execution pane to view the result summary and details.

NOTE. To manually fit the waveform into the mask, select Result in the Execution pane and click the Manual Fit button.

15. Click Result from the Execution pane to configure the report. Enter the Device Details, Port ID, Pair ID, and the Report File. You can specify that you want to automatically preview the report.
16. Select Summary from the Execution pane to generate and save a brief .csv report at C:\TekApplications\TDSET3\ReportGenerator\Reports.
17. Click Detail from the Execution pane to generate and save a detailed .rpt report at C:\TekApplications\TDSET3\ReportGenerator\Reports.
18. If you want to customize the report format, select Utilities > Report Generator. In the Generate Report tab, select the template and click the Generate button to post the test data to the template.

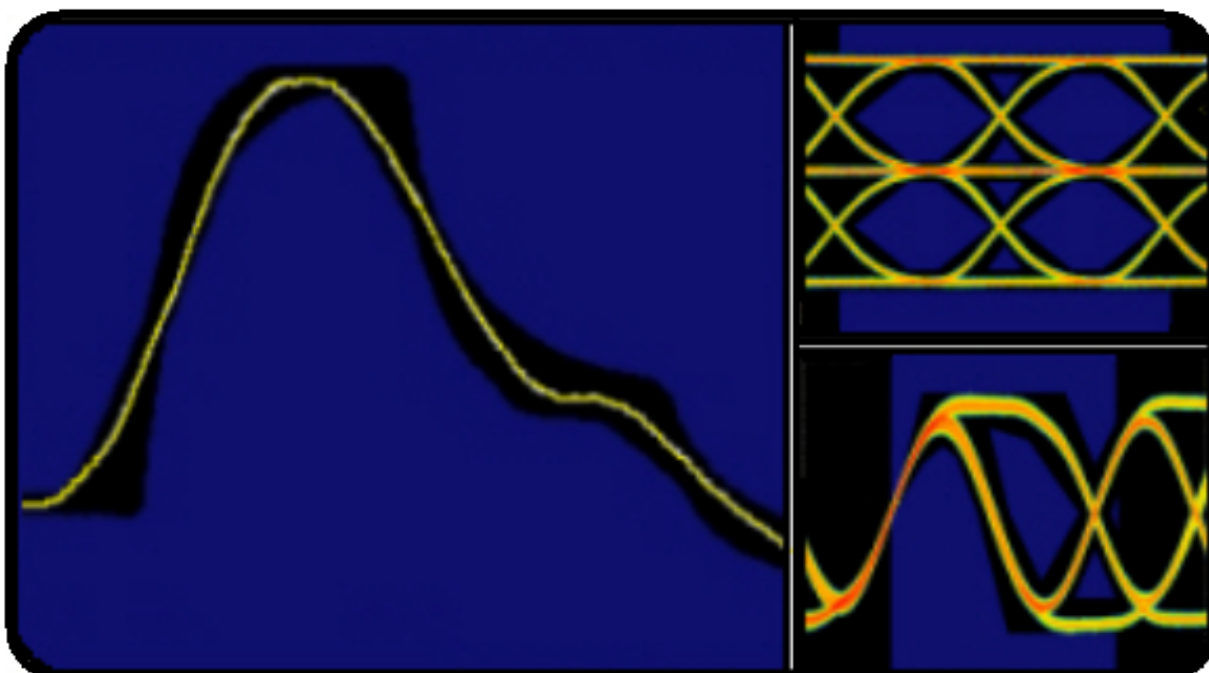

TDSET3 Ethernet Compliance Test Software Reference

www.tektronix.com



071-1881-00

TDSET3 Menu Tree

